



WorleyParsons
resources & energy



Sulphuric Acid Plant Fundamentals

Sulphuric Acid Short Course

Presented by

Douglas Louie

COM 2010
Vancouver, Canada
October 3-6, 2010

Contact Information

Douglas Louie
WorleyParsons Canada
Minerals and Metals
2645 Skymark Avenue
Mississauga, Ontario
L4W 4H2
Canada
905 212 7682
doug.louie@worleyparsons.com

Review the fundamentals of the sulphuric acid process, plant design and operation.

- Basics
- Types of Acid Plants
- Metallurgical Acid Plants
- Basic Reactions
- Catalyst
- Conversion
- Single vs. Double Absorption
- Plant Water Balance
- Autothermal
- Gas Drying
- Absorption
- Energy Recovery
- Emissions

Some topics are discussed briefly as a lead in to other presentations that are part of this short course.

Additional Resources

www.sulphuric-acid.com

There are three basic types of sulphuric acid plants:

Sulphur Burning

Acid Regeneration

Metallurgical

Acid regeneration plants include plants that decompose spent sulphuric acid into SO_2 and H_2O to be regenerated in to fresh acid and plants that take waste sulphur gases (H_2S , CS_2) to produce acid.

Some plants are a combination of two types of plants. Sulphur is sometimes burned in acid regeneration and metallurgical plants to increase SO_2 concentration and meet acid production requirements.

Sulphur Burning Acid Plants – Characteristics

- Elemental sulphur is a raw material
- Sulphur handling systems
- Sulphur furnace
- Energy recovery – steam production, electrical power generation
- Net energy producer



COM 2010, Vancouver, Canada, October 3-6, 2010

With increase in environmental awareness the amount of ‘involuntary’ acid produced by smelters has increased. The availability of smelter acid in some regions has caused some sulphur burning acid plants to shutdown. However, when reliability of supply and the energy produced by a sulphur burning acid plant is required, a sulphur burning acid plant still makes sense.

Acid Regeneration Acid Plants - Characteristics

- Regeneration furnace that decomposed H_2SO_4 into SO_2 and H_2O
- Fuel is burned to provide the energy to decompose acid
- Waste heat boiler to recover energy from gas leaving furnace
- Wet gas cleaning system

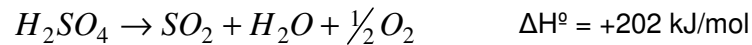

COM 2010, Vancouver, Canada, October 3-6, 2010

The largest acid regeneration plants are those associated with spent sulphuric acid that treat alkylation waste acid. The plants are usually located on the refinery site which avoids the need to transport the waste acid to the processing facility. A regeneration plant will also process spent acid from other nearby refineries.

The acid regeneration plant can also process hydrogen sulphide (H_2S) gas from the refinery reducing the load on sulphur recovery plants (Claus plants).

Water balance and low SO_2 concentrations are problems faced by acid regeneration plants due to low concentration waste acid feeds. In some cases, acid concentration plants are required to reduce water content and oxygen enrichment is used increase SO_2 concentrations and reduce gas volumes.

The decomposition of acid is an endothermic reaction which means energy is required to decompose the acid. A fuel is burned to provide the energy and much of the energy is recovered in the waste heat boiler that follows the decomposition furnace.

Metallurgical Acid Plants – Characteristics

- SO₂ gas comes from a wide variety of pyrometallurgical processes
- Wet gas cleaning system to remove impurities from the gas
- Both high and low SO₂ gas strengths
- Variable operation (flow and SO₂ concentration)
- Treatment of wet gas cleaning system effluent



COM 2010, Vancouver, Canada, October 3-6, 2010

Metallurgical acid makes up a significant and growing portion of the acid produced in the world.

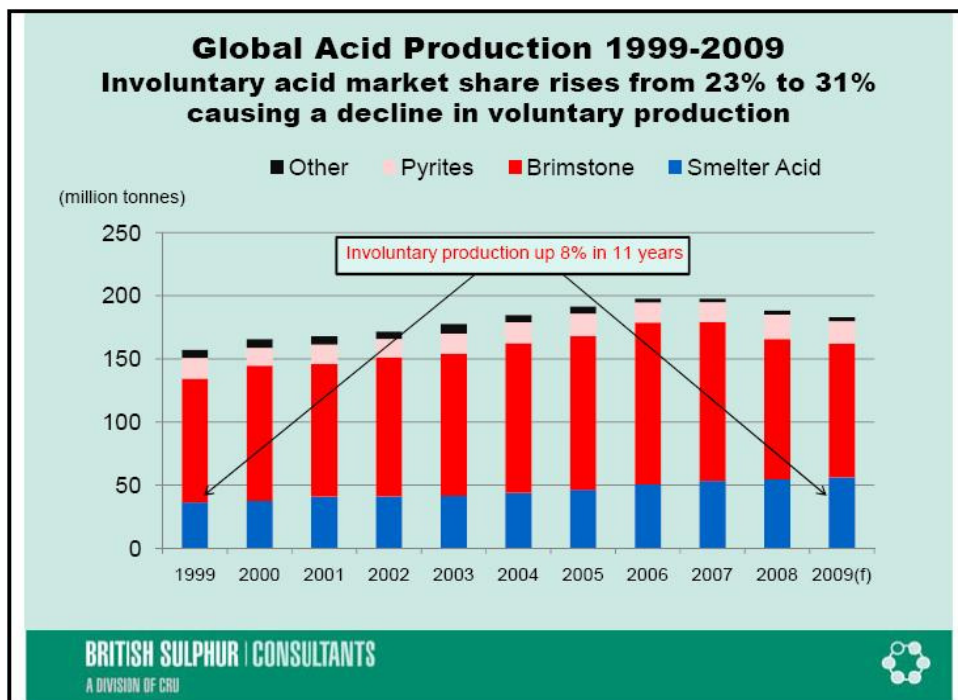

Process		Metal	% SO ₂
Roaster	Fluid Bed	Zn	9 to 11
Sinter Plant	General	Pb, Zn	1 to 8
	Front End of Sinter Machine	Pb	2.4 to 4
Flash Smelting	Outokumpu (65-75% O ₂ Enrichment)	Cu	34
	Inco (with oxygen)	Cu	75 to 85
	Contop	Cu	43
	30% O ₂ Enrichment	Cu	10 to 20
Converter	P-S (during blowing)	Cu	15 to 21
	P-S- (during charging)	Cu	1 to 7
Continuous Smelting	QSL	Pb	15 to 16
	Kivcet	Pb	25 to 40

Metallurgical sulphuric acid plants must be designed for a wide range of gas flows and conditions depending on the source of gas. Fortunately, technology suppliers have developed a wide range of processes, equipment and technology to handle almost every scenario.

The use of oxygen and oxygen enrichment in the metallurgical process can provide benefits to the acid plant by reducing gas volumes and increasing SO₂ concentrations. Gas cleaning systems can be made smaller with dilution air being added downstream just before the drying tower.

Contact sections can take advantage of the recent technologies designed to handle higher strength gases: pre-converters, LUREC, BAYQIK.

Impact on Metallurgical Acid Plant Design

- Acid plant operation is at the mercy of the upstream metallurgical operation.
- Variations in flow require constant adjustment of blower to maintain upstream draft. Consider the use of VFD motors for higher efficiency.
- Higher gas strengths means that energy recovery is possible
- Some metallurgical operations operate in a batch mode which results in highly variable gas conditions which the acid plant must handle.
- Gas cleaning system can range from relatively simple to complicated systems depending on the impurities in the gas and the requirement to produce a high quality product acid.

The importance of the acid plant has grown due to stricter environmental regulations which prohibit operation of the metallurgical operation without the acid plant.

The acid produced by a metallurgical operation is sometimes referred to as 'involuntary' acid because the smelter has no choice but to produce it.

The metallurgical operation and the metal that is produced is often considered more important than the by-product sulphuric acid. Operation and maintenance of the acid plant often suffered because of this misconception. Acid was sometimes disposed of at a loss just to get rid of it.

For a short period of time, sulphuric acid produced from a smelter was worth more to the company than the metal due to an unprecedented increase in the cost of acid.

Gas Cleaning Systems

Waste gases from the metallurgical process must be treated to reduce the sulphur dioxide emissions to the atmosphere. To achieve this the sulphur dioxide in the gas is converted to sulphur trioxide for the production of sulphuric acid in the sulphuric acid plant. The metallurgical off-gases must be cleaned prior to entering the contact section of the acid plant to enable the plant to produce a product acid of acceptable quality for use and sale. As well, clean gas is required to prevent plugging of catalyst beds and other detrimental effects on equipment such as corrosion and erosion.

Gas cleaning system comprise about 40 to 50% of the total capital cost of a metallurgical acid plant.

Gas Cleaning Systems

There are four main duties to be performed by the gas cleaning system of a metallurgical sulphuric acid plant:

1. SATURATION of the gases and ELIMINATION of the coarse and fine particulate matter,
2. COOLING of the gases, CONDENSATION of the metallic fumes and REDUCTION of the moisture content,
3. Removal of the very fine particulate matter as well as the bulk of the acid mist by ELECTROSTATIC PRECIPITATION to produce an optically clear gas which is fed to the acid plant downstream.
4. Specialty processes for removal of specific impurities in the gas (i.e. mercury removal, halogens)

Saturation – Adiabatic cooling and saturation of the gas is done in an open spray tower, low or high pressure drop venturi. Some removal of coarse particulate is achieved.

Elimination – The nature (type, concentration, size) of the impurity/dust determines the type of cleaning device required. Typically, high pressure drop venturi (fixed or variable throat), reverse jet scrubber (DynaWave), radial flow scrubber, etc. is required if dust loadings are high or particle size is small.

Cooling and Condensation – Removal of water from the gas is required to achieve the plant water balance. Direct contact devices (packed towers, tray scrubbers) or indirect cooling (star coolers, shell and tube condensers) are used to cool the gas and provide some removal of gaseous impurities.

Electrostatic Precipitation – Usually the last stage of gas cleaning before the drying tower. Removes the finest dust particles and acid mist.

Special Process – These include mercury removal (Boliden-Norzink), fluoride scrubbers, sodium silicate systems, etc.

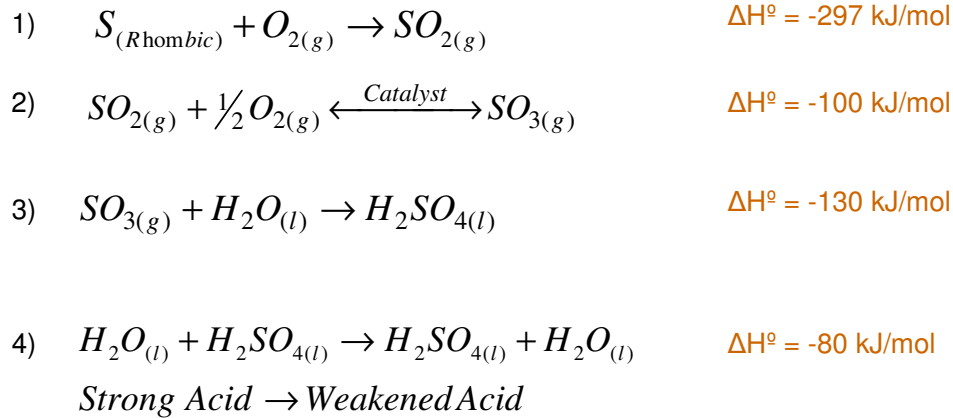

Reaction 2 is a reversible reaction. A reversible reaction is a reaction where the forward and reverse reaction proceed continually at the same time. Initially, the forward reaction rate is high producing SO_3 . As the quantity of SO_3 produced increases, the rate of the reverse reaction begins to increase while the rate of the forward reaction decreases. When the rate of the forward and reverse reaction are the same, the reaction has reached a state of equilibrium. At equilibrium the concentration of reactants and products does not change.

A catalyst is:

"A substance or material that will change the rate of reaction without it being consumed by the reaction."



Pellet



Ring



Star/Daisy

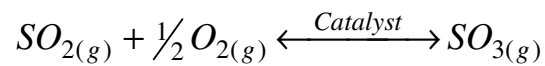

Pellet catalyst are the original catalyst form.

Ring catalyst provide a larger surface area to volume ratio than pellet catalyst. As well, ring catalyst provides lower pressure drop compared to pellet catalysts.

Star or daisy catalyst are a further improvement over ring shaped catalysts providing more surface area and lower pressure drop.

The active ingredient is vanadium pentoxide with a potassium as a promoter. Cesium promoted catalyst are more active which means that the reaction begins at a lower temperature (i.e. < 400°C).

$$K_P = \frac{P_{SO_3}}{P_{SO_2} \times P_{O_2}^{1/2}} \quad \log K_P = \frac{4956}{T} - 4.678$$

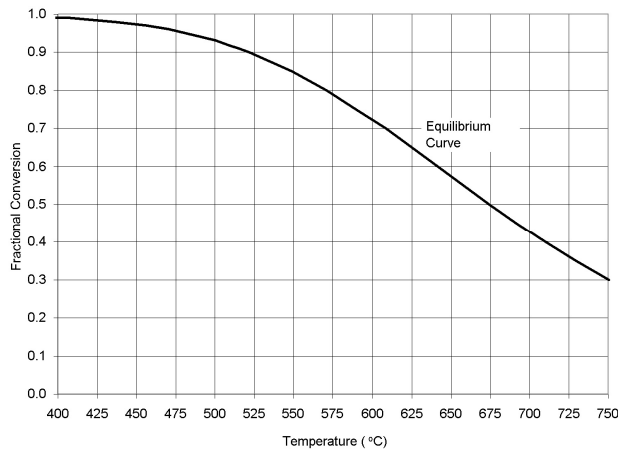

Solving the two equations together generates the equilibrium curve. Many different equilibrium equations have been proposed by researchers to describe observed experimental results and behaviour. Some of the variables that define the equilibrium equation are SO_2 and O_2 concentration (i.e. high vs. low), operating temperature and catalyst types.

Another equilibrium equation proposed (by Bodenstein) is:

$$\log K_P = \frac{5186.5}{T} + 0.611 \times \log T - 6.75$$

Shift in equilibrium curve with change in SO₂ concentration

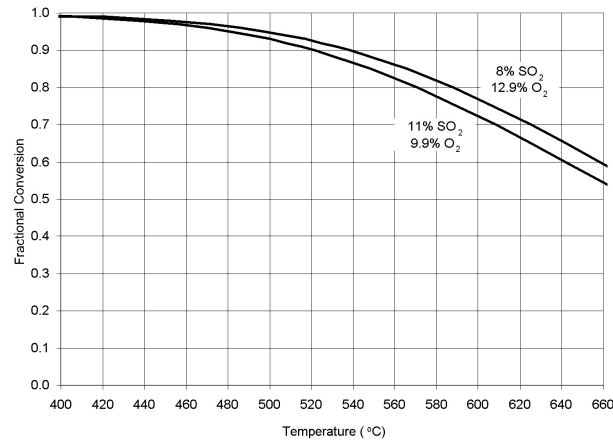

COM 2010, Vancouver, Canada, October 3-6, 2010

14

The equilibrium curve will shift upwards when the base SO₂ concentration is lower. That is why higher overall conversion can be obtained when SO₂ concentrations are lower. Unfortunately, diluting the gas to lower SO₂ concentration results in large gas flows and a larger more expensive plant.

Industry trends are to operate at higher SO₂ concentrations to reduce gas flow and plant size.

This shift in the equilibrium curve is important for double absorption plants.

Operating lines – Adiabatic and Isothermal

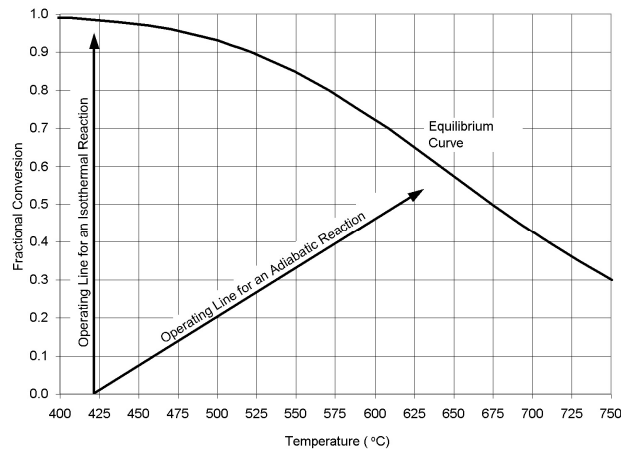

COM 2010, Vancouver, Canada, October 3-6, 2010

15

A purely isothermal reaction is not possible for the conversion of SO_2 to SO_3 because of the high rate in which heat is liberated from the reaction. The heat cannot be removed fast enough so some temperature rise will occur.

'Isothermal' converters were used in the early days of the contact process. As the size of plants increased, limitations were reached in the design of 'isothermal' converters so the adiabatic process was adopted.

Bayer Technology Services have recently developed a quasi-isothermal converter design which has been demonstrated at Berzelius BBH Stolberg in Germany. The technology uses a multi-tube reactor with catalyst loaded in the tubes. Cooling air is circulated on the shell side of the reactor to remove the heat of reaction.

Operating lines – High and low SO₂ concentrations

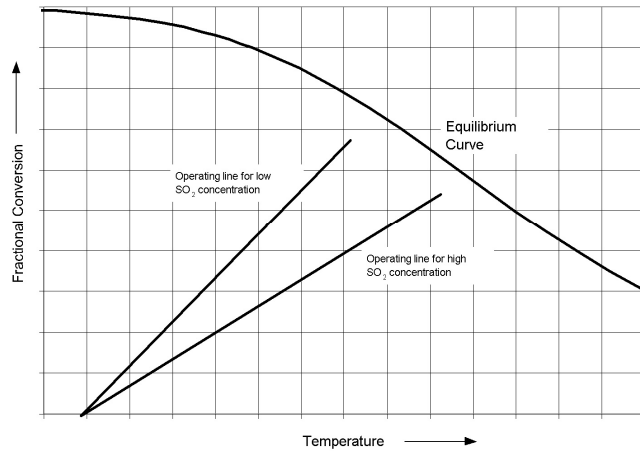

COM 2010, Vancouver, Canada, October 3-6, 2010

16

The angle of the operating line depends on the SO₂ concentration in the gas. The higher the SO₂ concentration, the lower the angle of the operating line. In an adiabatic converter, the heat of reaction raises the temperature of the process gas. The higher the SO₂ concentration, the fewer inerts (N₂, CO₂) are present to absorb the heat that is generated so the temperature rises more and equilibrium considerations result in lower conversions.

With low SO₂ strength gases, less heat is generated by the reaction to SO₃ and there are more inerts present so the temperature rise is less in an adiabatic reaction. The advantage of a weak gas is that higher conversions can be obtained.

Response at equilibrium conditions

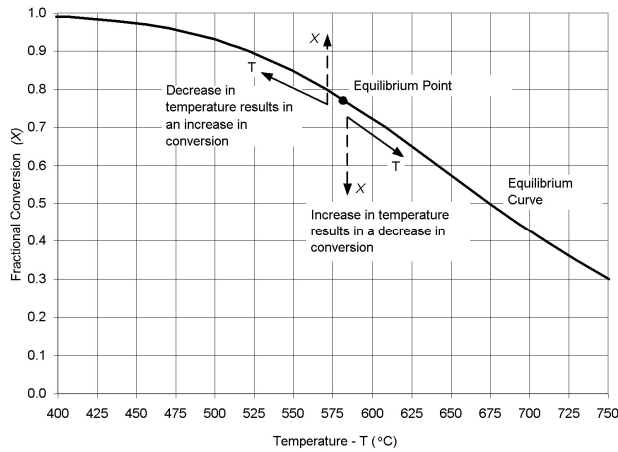

COM 2010, Vancouver, Canada, October 3-6, 2010

17

For a reaction that has reached equilibrium, the extent of the reaction can be altered by adjusting the temperature of the gas provided that the gas remains in contact with the catalyst. Raising the temperature of the gas will lower the conversion by causing SO_3 to convert back to SO_2 and O_2 .

In contrast, lowering the temperature of the gas will cause more SO_2 to react with the oxygen present to form SO_3 , increasing the overall conversion.

The key to this is that the reactants and product must always be in the presence of a catalyst.

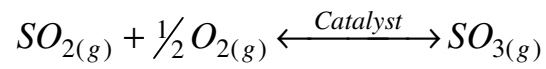

Le Chatelier's Principle

In 1888 Henri-Louis Le Chatelier (1850 - 1936), a French industrial chemist made the observation:

Any change in one of the variables that determines the state of a system in equilibrium causes a shift in the position of equilibrium in a direction that tends to counteract the change in the variable under consideration.

Simply put, Le Chatelier's Principle states that a system in equilibrium responds to any stress by restoring the equilibrium. The reaction of sulphur dioxide with oxygen to form sulphur trioxide follows the principles outlined by Le Chatelier.

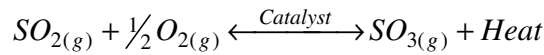

**Temperature**

- Because heat is generated in the reaction, removing heat will result in more SO₃ formation

Pressure

- SO₂ and O₂ represent 1½ volumes of reactants while SO₃ is only 1 volume. Therefore increasing the pressure at which the reaction occurs will result in more SO₃ formation

Concentration of Products and Reactants

- Removing reaction products will result in the formation of more products

Le Catelier's Principle

Temperature

The stage-wise reaction with cooling in between catalyst beds uses the principle of removing heat (i.e. lower temperature) to achieve higher overall conversions. This is the same principle used in an 'isothermal' converter.

Pressure

The impact of pressure is not significant for the standard contact process. However, a pressure sulphuric acid plant was developed and several plants were built using the principle that operating at higher pressures promotes the formation of SO₃.

Concentration of Products and Reactants

The removal of SO₃ from the gas mixture to promote higher overall conversions is the principle behind the double absorption plant

Example
Single Absorption

SO₂: 9%
O₂: 13.2%

Bed 1: 72.2%
Bed 2: 92.7%
Bed 3: 96.3%
Bed 4: 97.5%

Bed 1: 410°C
Bed 2: 450°C
Bed 3: 425°C
Bed 4: 420°C

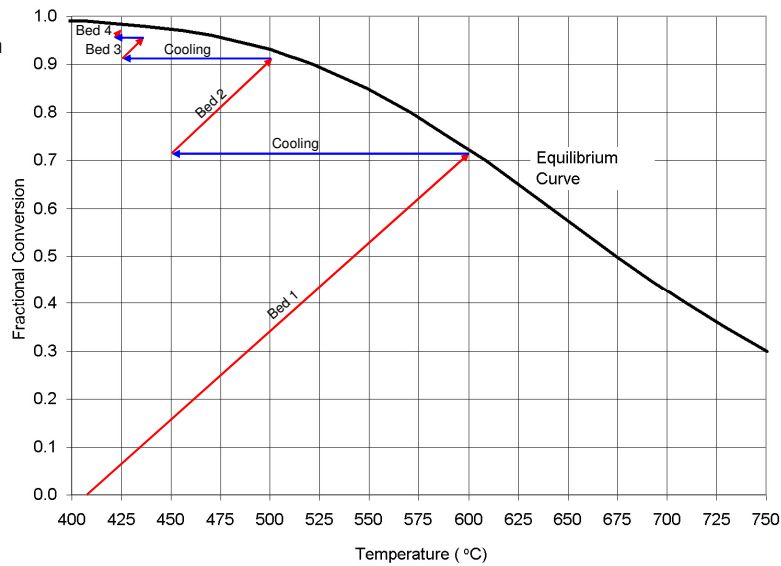

The operating lines plotted on the equilibrium curve show that the reaction approaches the equilibrium curve but never quite reaches it. In order to reach equilibrium a large amount of catalyst and residence time is required.

The rate of reaction is not shown but plays an important part in determining the inlet temperatures and the amount of catalyst required. If the initial temperature is too low, the rate of reaction is low so more catalyst is required.

The optimum reaction path is determined in conjunction with the catalyst suppliers and is a compromise between the amount of catalyst volume and size of the gas-to-gas heat exchangers.

Example
Double Absorption

SO₂: 11%
O₂: 10%

Bed 1: 64.0%
Bed 2: 87.6.0%
Bed 3: 94.8%
Bed 4: 99.8%

Bed 1: 415°C
Bed 2: 450°C
Bed 3: 450°C
Bed 4: 425°C

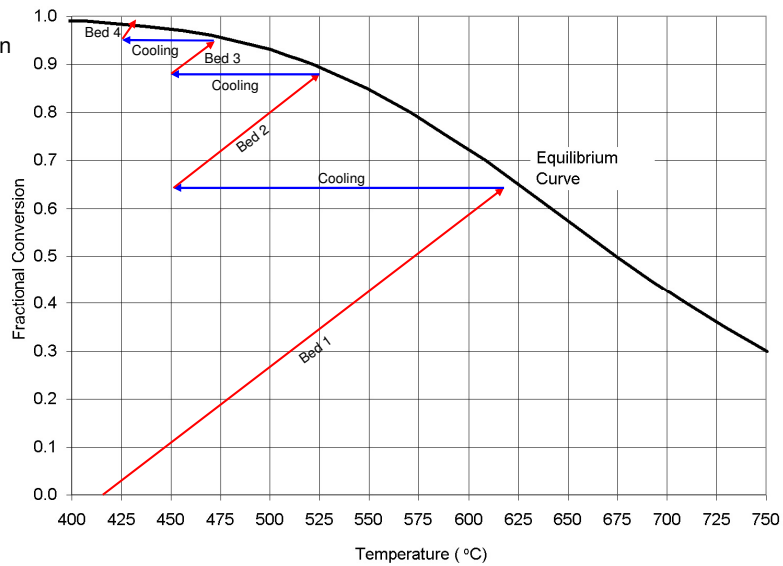

The reaction path for the double absorption example is not directly comparable to the single absorption path because of the different gas compositions. The basic steps of reaction and cooling are the same but the temperatures and conversions are for 11% SO₂ and 10% O₂.

Despite the higher SO₂ concentration, a higher overall conversion is achieved because of the absorption and removal of the SO₃ that is formed through the first three catalyst beds.

Example

Double Absorption

SO₂: 11%

O₂: 10%

Bed 1: 64.0%

Bed 2: 87.6.0%

Bed 3: 94.8%

Bed 4: 99.8%

Bed 1: 415°C

Bed 2: 450°C

Bed 3: 450°C

Bed 4: 425°C

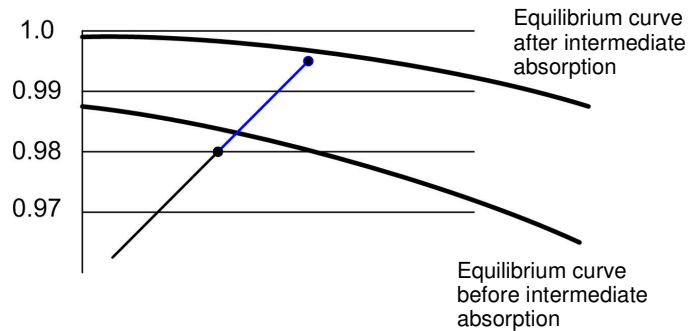

After the SO₃ is removed in the intermediate absorber the new gas composition is effectively much lower in terms of SO₂ concentration and a new equilibrium curve applies. In the example, the original equilibrium curve is based on 11% SO₂ and 10% O₂. After the intermediate absorber the new equilibrium curve is based on 0.68% SO₂ and 5.67% O₂. The lower SO₂ concentration shifts the equilibrium curve up which allows higher conversions to be obtained.

Gas-to-Gas Heat Exchanger

Interchange of heat with process gas for heating and cooling

BFW, WHB or Superheater

Recovery of heat into steam system

SO₃ Cooler

Cooling of process gas using ambient air in a heat exchanger

Gas Quenching

Mixing of cold and hot gas

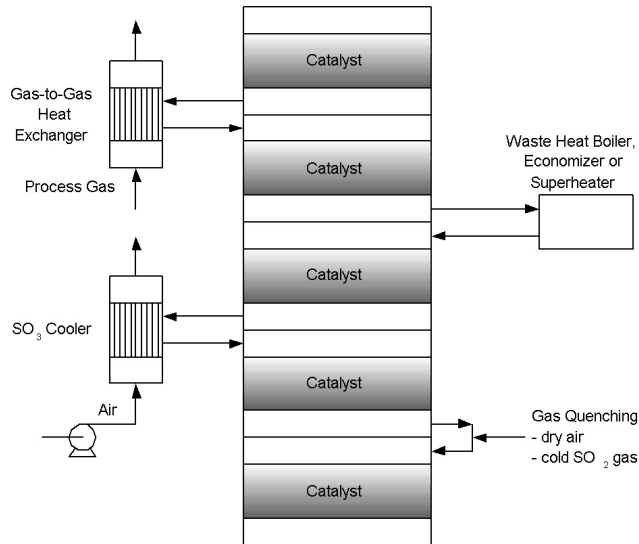

Gas-to-Gas Heat Exchangers

Heat from the process reaction is used to heat the incoming cold gas or to reheat the gas returning from the intermediate absorber tower.

BFW, WHB or Superheater

High process temperatures allow for the generation of high pressure steam or to superheat steam going to a turbo-generator. Typically, found in sulphur burning acid plants. May be used in some metallurgical plants where high SO₂ gases are treated. Economizers are generally not used as standalone cooling devices between beds.

SO₃ Cooler

Hot air is generally vented to atmosphere. In some cases there is an opportunity to use to hot air for process duties, energy recovery or to aid in the dispersion of other stack gases.

Gas Quenching

Technique not frequently used. Was used in single absorption plants to cool gas between bed 3 and 4 where the heat load was not high. Also used in some cases to increase oxygen content of gas.

Single Absorption

- Also known as Single Contact
- Characterized by a single SO₃ absorption tower
- On their own, they no longer meet emission regulations

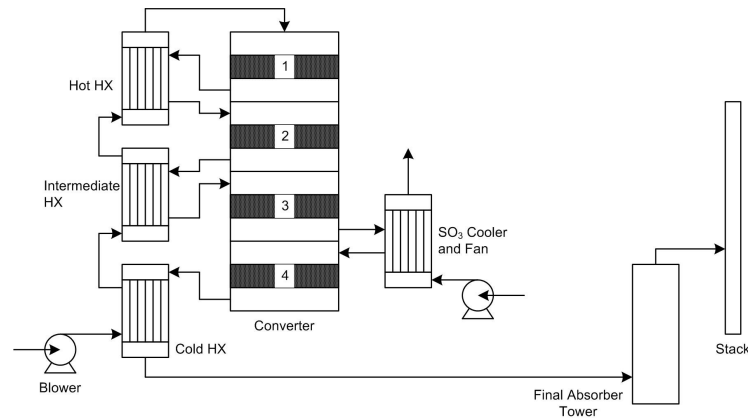

COM 2010, Vancouver, Canada, October 3-6, 2010

24

Single absorption plants on their own cannot meet current emission regulations. Single absorption plants can be retrofitted and converted to double absorption or a tail gas scrubber installed at the exit of the absorber to remove the SO₂.

Single absorption plants were designed with 3 or 4 catalyst beds. In the 3 bed design, the SO₃ Cooler and Fan are not required. Some plants were designed with 4 beds but no cooling was provided between the 3rd and 4th beds. Without cooling between the beds the separate beds function essentially as a single bed with lots of catalyst.

Cooling between the 3rd and 4th beds makes the plant a true 4 bed single absorption plant. Cooling can be done in a number of different ways: SO₃ cooler, air dilution/quench, radiant duct and process gas quench.

Double Absorption

- Also known as Double Contact/Double Absorption
- Characterized by two SO₃ absorption towers

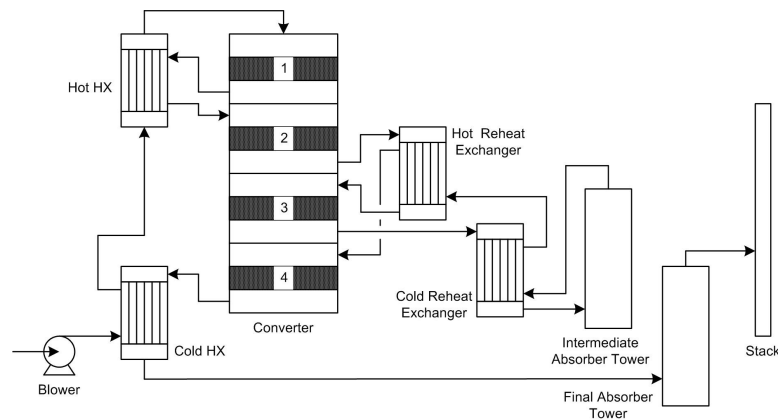

COM 2010, Vancouver, Canada, October 3-6, 2010

25

Double absorption plants are able to meet current emission restrictions for SO₂. The design can be adjusted to provide for energy recovery, handling both high and low strength gases.

Double absorption plants are more expensive than single absorption plants due to the additional equipment.

From an energy recovery point of view, more energy can be recovered from a single absorption plant than a double absorption plant because the heat used to reheat the gas returning from the intermediate absorber tower can be recovered in a single absorption plant.

Double Absorption Plant Arrangements

2/1 Arrangement - 2 catalyst beds before intermediate absorber followed by 1 catalyst bed. Will not meet current emission regulations.

2/2 Arrangement - 2 catalyst beds before intermediate absorber followed by 2 catalyst beds. Used by Lurgi in many plants around the world.

3/1 Arrangement - 3 catalyst beds before intermediate absorber followed by 1 catalyst bed. Standard arrangement for the modern contact sulphuric acid plant for obtaining SO₂ emissions of 4 lb/ST (2 kg/MT) or 99.7% conversion.

3/2 Arrangement - 3 catalyst beds before intermediate absorber followed by 2 catalyst beds. Used when high overall conversions (>99.9%)/low SO₂ emissions are required.

Higher overall conversions can be obtained using caesium catalyst in the 3/1 arrangement. The acid plant at Kennecott, Utah operates with 14% SO₂ (dry gas) and an O₂:SO₂ ratio of 0.986 and can achieve less than 100 ppm SO₂ in the stack.

Plants with 3/2 arrangements are a regulatory requirement in some parts of the world to ensure low SO₂ emissions and are considered Best Available Technology (BAT).

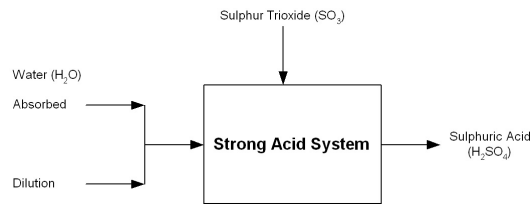

The plant water balance is the point at which the incoming water meets the exact requirements for producing acid at the desired strength. If the plant is not in water balance, the desired acid concentration cannot be maintained and will decrease.

In a metallurgical acid plant, the plant water balance is characterized by the temperature of the gas leaving the gas cleaning system (i.e. gas cooling system) and entering the plant drying tower.

Acid is made up of SO_3 and water. In a sulphur burning plant, a small amount of water comes in with the atmospheric air required for sulphur combustion. The majority of water is added as dilution water in the absorber system. In a metallurgical or regeneration acid plant, considerably more water enters the contact section of the acid plant with the gas exiting the gas cleaning system. If there is too much water in the gas or the SO_2 concentration is low, the proportion of water to SO_3 that is produced may be too high to produce acid at the desired concentration.

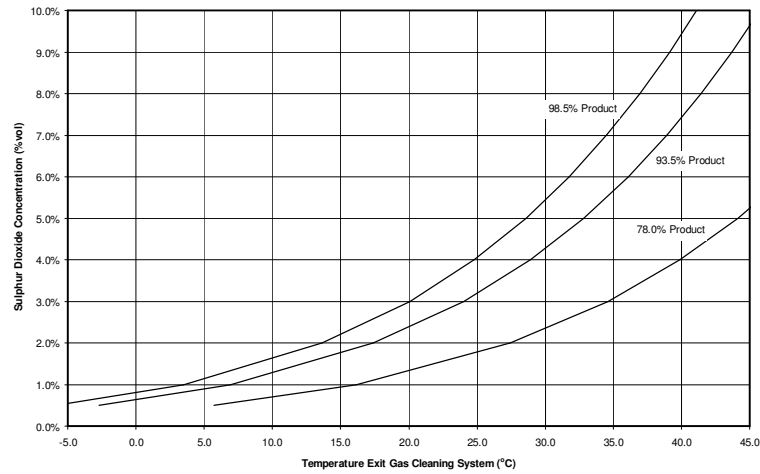

Note: Curves are specific to an operating pressure and overall conversion of the plant.

The barometric pressure has an impact on the partial pressure of water in the gas and the operation of the gas cooling system.

At the same temperature, gas at a lower absolute pressure will contain proportionally more water than gas at a higher absolute pressure.

It will be more difficult for a plant located at high elevation to meet the plant water balance than a plant located at sea level.

If there is a problem with the plant water balance, the following can be done:

- Produce a lower strength product acid (i.e. 98% → 93%)
- Cool the gas exiting the gas cleaning more → chilled water system
- Increase SO₂ concentration by burning sulphur, reducing air ingress, liquid SO₂ injection, etc.
- Fortify product acid with higher strength acid (i.e. oleum)
- Pre-drying tower

Water balance problems typically occur during the warmer months when ambient temperatures (wet bulb) are higher and cooling water supply temperatures cannot be maintained. The temperature of the gas leaving the wet gas cleaning system is higher and contains more water. If gas strengths are low then water balance problems can occur.

The first indication will be the reduction in the amount of dilution water being added to the absorber acid system. When the flow drops to zero control of the acid concentration will be lost and the concentration will begin to decrease.

The autothermal limit of a plant is the minimum SO₂ concentration at which the heat generated by the SO₂ to SO₃ reaction in the converter balances with the amount of heat required to heat the cold gas up to the catalyst ignition temperature.

At lower SO₂ concentrations, there is insufficient heat generated and the temperatures in the converter can not be maintained. The converter temperatures will begin to decrease and eventually fall below the auto-ignition temperature of the catalyst.

Converter temperatures can be maintained by the addition of heat from an outside source such as from the operation of a preheat system.

The autothermal limit of a plant is generally set by the size of the Cold or Cold Reheat Exchangers. The larger the heat exchangers, the greater the amount of heat that can be recovered to heat the cold gases entering the converter.

The lower practical limit for operating a contact sulphuric acid plant is about 2% SO₂. Even at this concentration the plant must incorporate special features to meet the plant water balance and maintain sufficient heat in the contact section. Double absorption is not possible nor is it required to meet plant emissions.

A feature to help with the plant autothermal limit is an interpass system bypass. Hot gas from bed 3 is bypassed around the interpass tower directly back to bed 4. This allows bed 4 temperature to be maintained. If all the gas is bypassed around the interpass tower, the plant effective is converted from a double to single absorption plant.

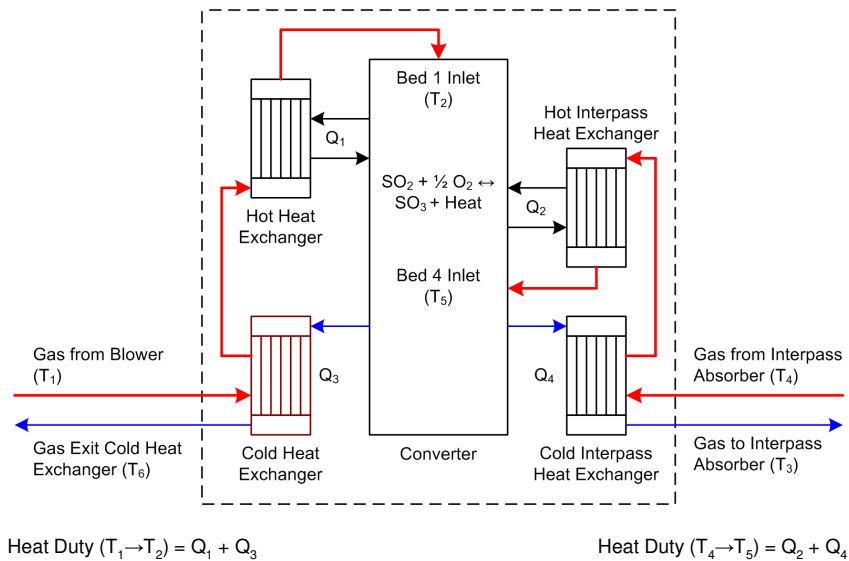

When a 'box' is put around the converter and heat exchangers of an acid plant, there are four streams entering and exiting the box. We ignore heat losses outside of the box because the equipment is insulated and the heat losses that do occur are small in comparison.

The gas conditions from the blower and interpass absorber are fixed in terms of temperature and do not vary a lot when the plant is operating.

The only gas streams whose temperature can vary are the streams leaving the cold and cold interpass heat exchangers.

When the SO_2 concentration is low, less heat is generated by the conversion to SO_3 . The only place to extract more heat from the system to maintain the heat balance is from the gas leaving the cold and cold interpass heat exchangers. Therefore, it is the sizing and the ability of the cold and cold heat exchangers to transfer heat that determines how low the SO_2 concentration can go before the heat balance cannot be maintained which is the autothermal limit of the plant.

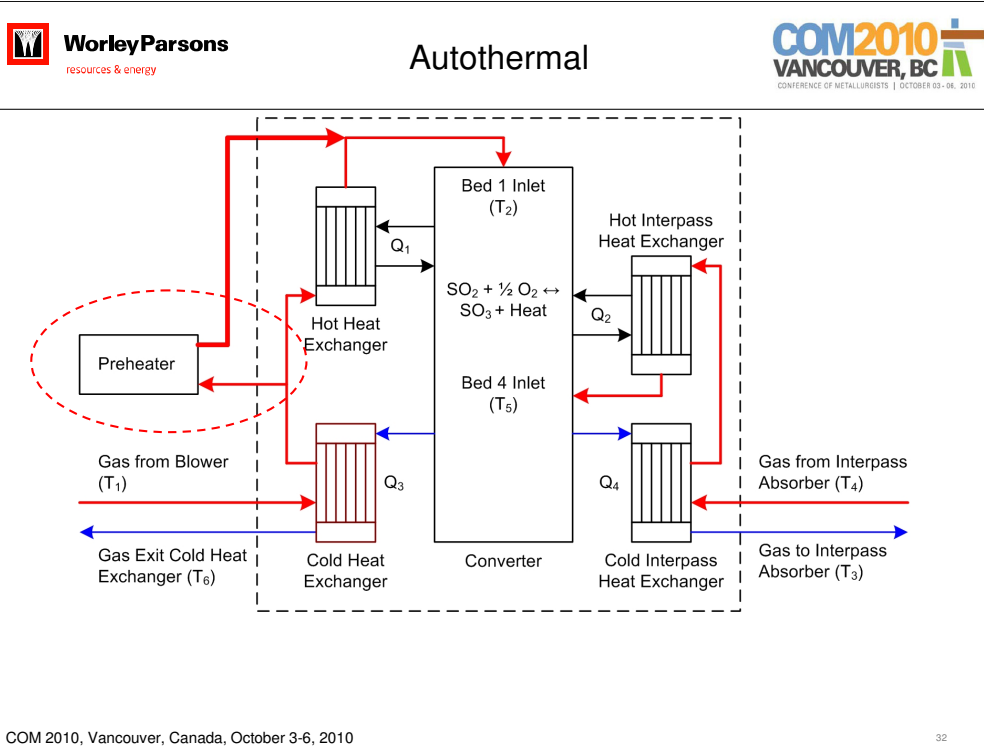

When the reaction of SO_2 to SO_3 generates insufficient heat to perform the heating duties, the converter bed temperatures cannot be maintained. In this case, the preheater can be used to input additional heat into the system. A portion of the process gas from the outlet of the Cold Heat Exchanger is sent to the preheater where fuel is burned to input heat into the process gas. The hot process gas then rejoins the rest of the process gas leaving the Hot Heat Exchanger going to the inlet of Bed 1.

Other things that can be done to maintain plant operation when SO_2 concentrations are low are:

- Ensure heat exchangers are clean, particularly the Cold and Cold Interpass Heat Exchangers to maximize heat transfer.
- Use 'low-bite'/low-ignition catalyst in bed 1 to reduce the heating duty required to heat the cold process gas to bed 1 inlet temperature
- Install a bypass upstream of the Interpass Absorber Tower to divert process gas around the absorber. When all the gas is fully bypassed, the plant converts from a double absorption plant to a single absorption plant.
- Maintain insulation on the converter, heat exchangers and ducting.

Absorption occurs because there is driving force and a need to reach a state of equilibrium.

In an acid plant drying tower, water enters the bottom of the tower at a high concentration relative to the concentration of water in the acid, so water is absorbed by the acid and the gas is dried.

In an acid plant absorption tower, SO_3 enters the bottom of the tower at a high concentration relative to the concentration of SO_3 in the acid, so absorption occurs.

The extent of absorption is determined by the conditions at the top of the tower.

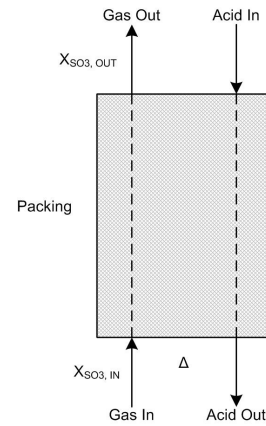

The absorption of SO_3 into sulphuric acid is said to be 'gas phase controlled' which means that it is the behaviour of SO_3 in the gas phase that determines the rate of absorption. The determining factor is how quickly SO_3 will diffuse/move through the gas to liquid surface of the liquid. Once SO_3 comes in contact with the acid, it is immediately absorbed. There is no concentration build-up of SO_3 at the gas-liquid interface that would inhibit further absorption of SO_3 . The absorption of water into sulphuric acid is also gas-phase controlled.

The rate of absorption can be improved by maximizing contact between the gas and liquid phases. A well designed packing maximizes surface area between gas and liquid while minimizing pressure drop. The packing must also promote continual renewed of the liquid surface to bring fresh acid in contact with the gas.

The design and operation of an absorber tower is mass transfer problems as well as a heat transfer problem because of the heat of absorption associated with the absorption of SO_3 into sulphuric acid.

Purpose

Drying of the gas is necessary to:

- Avoid corrosion caused by wet SO₂ gas before the converter and wet SO₃ gas after conversion
- Avoid loss of production due to the formation of acid mist in the absorber tower
- Maintain a clear stack
- Avoid condensation during shut downs and thus protect the catalyst from degrading

Factors Affecting Drying

Factors Affecting Drying

- Acid Concentration
- Acid Temperature
- Tower Design – type of packing and packing height
- Gas and Liquid Distribution
- Gas Flow
- Acid Flow
- Water content in gas



The drying performance of the system can be monitored by measuring the dewpoint of the gas. This can be done periodically by sampling the gas and using an Electrodryer. A gas stream is directed over a cooled mirror surface. When condensation first appears on the surface the temperature corresponds to the dewpoint of the gas.

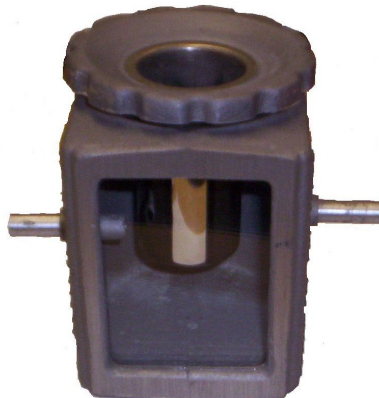

Excessive amounts of acid collected in the gas-gas heat exchanger drains can also be an indication of poor drying tower operation. Heat exchanger drains should be checked periodically.

An on-line dewpoint analyzer can also provide an indication of drying tower performance. An increase in dewpoint downstream of the tower will indicate a reduction in gas drying.

Drying

Temperature		Vapour Pressure			Moisture Content	
°C	°F	mmHg	psia	mbar	g/kg DA	g/m ³ DA
10	50	9.2107	0.1781	12.28	7.632	9.851
0	32	4.5845	0.0886	6.1121	3.775	4.873
-10	14	1.9494	0.0377	2.599	1.6	2.065
-20	-4	0.7745	0.0150	1.0326	0.635	0.819
-30	-22	0.2581	5.5127(10 ⁻³)	0.3802	0.233	0.301
-40	-40	0.0964	1.8631(10 ⁻³)	0.1285	7.887(10 ⁻²)	0.102
-50	-58	0.0295	5.7121(10 ⁻⁴)	0.0394	2.418(10 ⁻²)	3.121(10 ⁻²)
-60	-76	0.0081	1.5682(10 ⁻⁴)	0.0108	6.638(10 ⁻²)	8.568(10 ⁻³)

A dewpoint of -40°C/°F is the typical design basis for a drying tower. This dewpoint has proven to be easily achievable and provides sufficiently dried gas to minimize downstream problems related to acid condensation and corrosion.

There are so-called 'wet sulphuric acid' process plants that do not require the gas to be dried to produce sulphuric acid. Process is based on the conversion of SO_2 to SO_3 in a wet gas and the subsequent condensation of sulphuric acid from the gas when it is cooled.

Haldor Topsoe
WSA Process (typical)

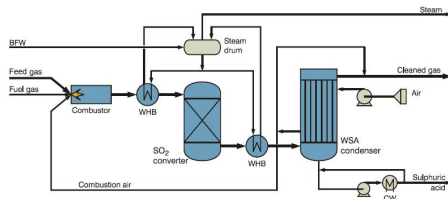

KVT Process Technology
Sulfox Process (typical)

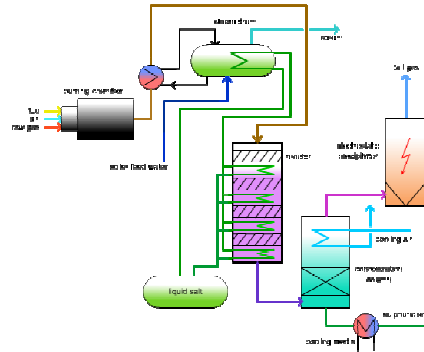

Absorption

Factors Affecting Absorption

- Acid Concentration
- Acid Temperature
- Tower Design – type of packing and packing height
- Gas and Liquid Distribution
- Gas Flow
- Acid Flow
- Concentration of SO₃ in the gas

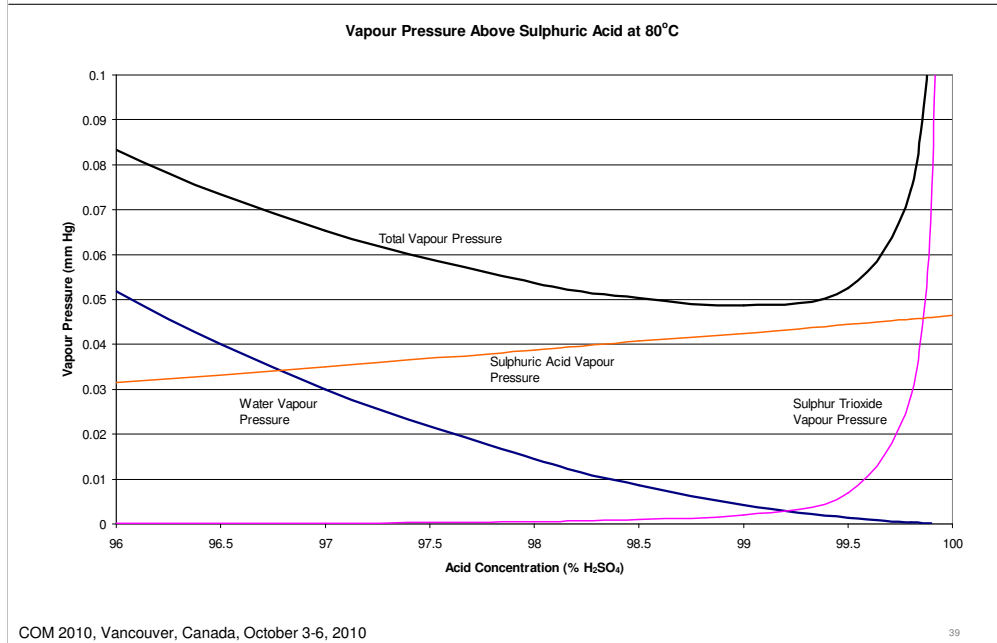

The vapour pressure above sulphuric acid is made up of three components: H₂SO₄, SO₃ and H₂O. The partial pressure of water decreases as the concentration of sulphuric acid increases reaching essentially zero at 100% H₂SO₄. On the other hand, the partial pressure of SO₃ is essentially zero through the range of 0 to 97% H₂SO₄ at which point it begins to rise. As the concentration of sulphuric acid approaches 100% H₂SO₄ there is a rapid rise in SO₃ partial pressure which is indicative of the formation of fuming sulphuric acid or oleum. The partial pressure of H₂SO₄ rises gradually over the entire acid concentration range.

When the total vapour pressure is calculated from the sum of all three components, it is seen that the total vapour pressure goes through a minimum in the 98 to 99.5% H₂SO₄ concentration range which forms the basis for the normal operation of an absorber tower in this concentration range.

At higher operating temperatures, the partial pressure of all components increases which makes the absorption of SO₃ more difficult.

At lower operating temperatures the partial pressure of SO₃ is lower which favours the absorption of SO₃ into the circulating sulphuric acid. However, plant operators know that when the temperature of their absorber acid is too low, absorption efficiency is reduced. When SO₃ is absorbed into sulphuric acid it does not immediately react with water to form sulphuric acid but forms an intermediate (H₂SO₄/SO₃). This intermediate then reacts with water to form sulphuric acid. At lower temperatures, the reaction between the intermediate H₂SO₄/SO₃ and water to form sulphuric acid slows down. The intermediate increases the vapour pressure of SO₃ which decreases the absorption efficiency despite the fact that lower temperatures generally mean lower vapour pressures.

Thus, there is an optimum range of concentration and temperature in which absorption efficiency of SO₃ is maximized. The optimum operating conditions for a particular absorber is a function of many factors including acid concentration and temperature and is unique to each plant.

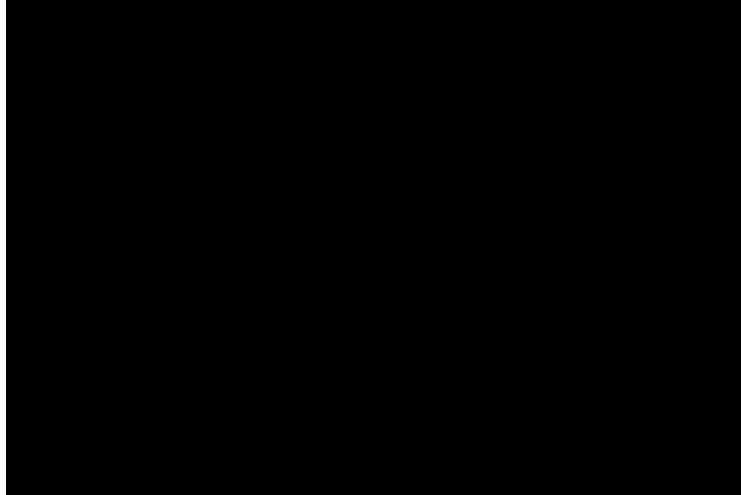

Most acid plants have a slight visible plume. The viewing angle, direction of the sun, colour of the sky, cloud cover, etc. all impact on how visible the stack appears.

Stack spitting can also occur if there is too much condensation in the stack. Small droplets or sulphate particles are entrained in the gas leaving the stack and fall out in the surrounding area. The usual evidence of stack spitting is the small discolouration seen on the paint finish of cars parked in the vicinity of the plant.

Failure to Absorb

Poor operation of the Absorber Tower usually manifests itself to the operator in the following ways:

- Visible plume from the acid plant stack
- Fall out of acid mist or droplets
- Excessive liquid (acid) discharge from the drains of the stack

Most acid plants have a slight visible plume. The viewing angle, direction of the sun, colour of the sky, cloud cover, etc. all impact on how visible the stack appears.

Stack spitting can also occur if there is too much condensation in the stack. Small droplets or sulphate particles are entrained in the gas leaving the stack and fall out in the surrounding area. The usual evidence of stack spitting is the small discolouration seen on the paint finish of cars parked in the vicinity of the plant.

Failure to Absorb



COM 2010, Vancouver, Canada, October 3-6, 2010

The stack plume is the result of the loss of concentration control in the final absorber tower forming oleum in the system.

Even when the acid concentration is returned to normal the stack plume may still continue. The mist eliminators become saturated with oleum and continues to release SO_3 even if the circulating acid concentration is returned to normal. It takes time for sufficient 'weaker' acid to be carried up into the mist eliminators to dilute the oleum in the mist eliminators back to normal to stop the stack plume.

The chemical reactions associated with sulphuric acid production are exothermic (i.e. energy is released).

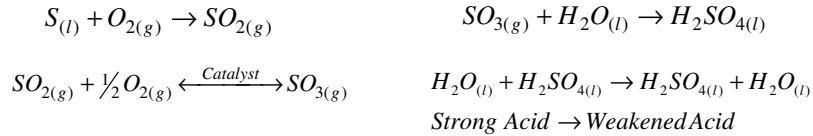

In a sulphur burning acid plant, high pressure steam can be produced from the heat released from the burning of sulphur and conversion of SO₂ to SO₃.

In a metallurgical plant, energy can be recovered if the SO₂ strength is high enough such that there is excess heat available from the conversion of SO₂ to SO₃.

In all plants, energy can be recovered from the absorber acid system in the form of hot water, low pressure steam, etc.

High pressure steam is the most useful form in which the energy can be recovered. It can be used to drive the main blower through a steam turbine drive or generate electrical power in a turbo-generator. In some cases high pressure steam can be used for process applications (i.e. HPAL). High pressure steam can be letdown to lower pressures to meet other steam consumption requirements.

Low pressure steam generated in the strong acid system can be used for process uses. Its real advantage is replacing high pressure steam that has been letdown to lower pressures. This technique make more high pressure steam available for power generation without the loss of efficiency associated with simply reducing its pressure through a letdown valve.

Hot water can be used for process heating duties, district heating, desalination, etc. Unfortunately, some of the duties are seasonal so backup cooling methods must be provided. As well, the quantity of hot water generated is large so it is sometime difficult to find a use for it all.

Metallurgical acid plant energy recovery

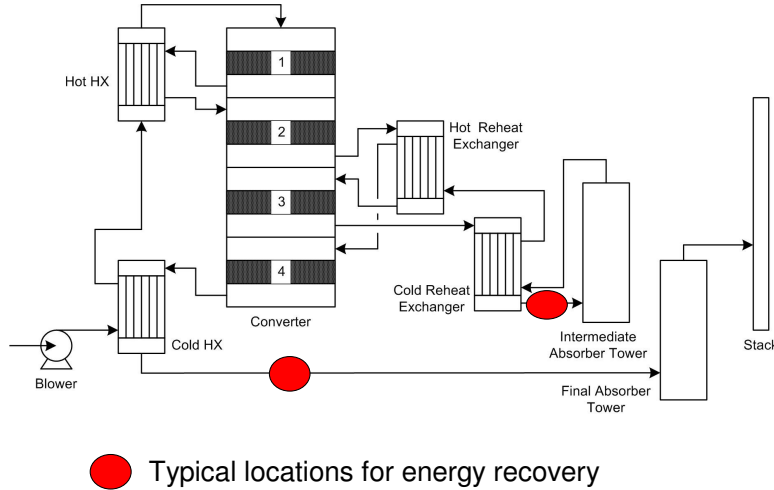

The outlet of the cold and cold reheat exchangers is the typical location for energy recovery in a metallurgical sulphuric acid plant. If the plant is operating with high SO_2 concentrations some of the heat generated by the reaction to SO_3 will not be required for gas heating duties. This excess energy will be present at the outlet of the cold and cold reheat exchangers (see Autothermal discussion). Options for energy recovery are typically a waste heat boiler and/or economizer.

Usually temperatures are not high enough and there is insufficient energy to produce superheated steam.

Typically, only 'low' grade energy can be recovered from the strong acid system in the form of hot water or low pressure steam.

MECS HRS is the typical process used for producing low pressure steam. There are 5 installations in metallurgical sulphuric acid plants.

Considerations for energy recovery in a metallurgical acid plant

- Consistency of plant operation in terms of gas flow and SO₂ concentration.
- Overcooling of gas leading to acid condensation and corrosion problems.
- Return on investment
- Overall site steam and energy balance

The HRS installations in metallurgical sulphuric acid plants are:

LS Nikko I – South Korea: Copper

LS Nikko II – South Korea: Copper

ETI – Turkey: Pyrite

Kennecott – USA: Copper

Xstrata – Norway: Nickel

USA Code of Federal Regulations

Title 40 – Protection of Environment

Part 60 – Standards for Performance for Stationary Sources

Subpart H – Standards of Performance for Sulfuric Acid Plants

Sulphur Dioxide: 2 kg/metric tonne of acid produced (100% basis)
(40 CFR 60 Subpart H 60.82)

Sulphuric acid mist: 0.075 kg/metric tonne of acid produced (100% basis)
Opacity: < 10 opacity
(40 CFR 60 Subpart H 60.83)

Recent changes in US legislations

Many USA sulphuric acid producers have come under “Consent Decrees” that require them to reduce present SO₂ emissions from their plants. Many have installed tail gas scrubbers to meet the more stringent requirements.

June 2, 2010 – US EPA strengthens the primary National Ambient Air Quality Standards (NAAQS) for sulphur dioxide (SO₂).

The existing (since 1971) annual average (30 ppb) and 24-hour (140 ppb) primary SO₂ standards are replaced with a new 1-hour SO₂ standard set at 75 parts per billion (ppb).

Primary standards focus on the public health.

The changes are targeting the power industry and coal fired power stations.

Secondary standard for SO₂ which is designed to protect the public welfare and environment is part of a separate review to be completed in 2012.



WorleyParsons
resources & energy



Sulphuric Acid Plant Fundamentals

Sulphuric Acid Short Course

Presented by

Douglas Louie

COM 2010
Vancouver, Canada
October 3-6, 2010

Contact Information

Douglas Louie
WorleyParsons Canada
Minerals and Metals
2645 Skymark Avenue
Mississauga, Ontario
L4W 4H2
Canada
905 212 7682
doug.louie@worleyparsons.com